

REVISION HISTORY				
REV	ECO	DESCRIPTION	DATE	APPROVED
-	-	-	-	-

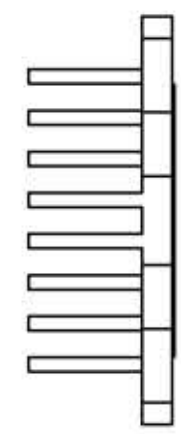

Chomerics T710 Interface Material
18mmx18mm

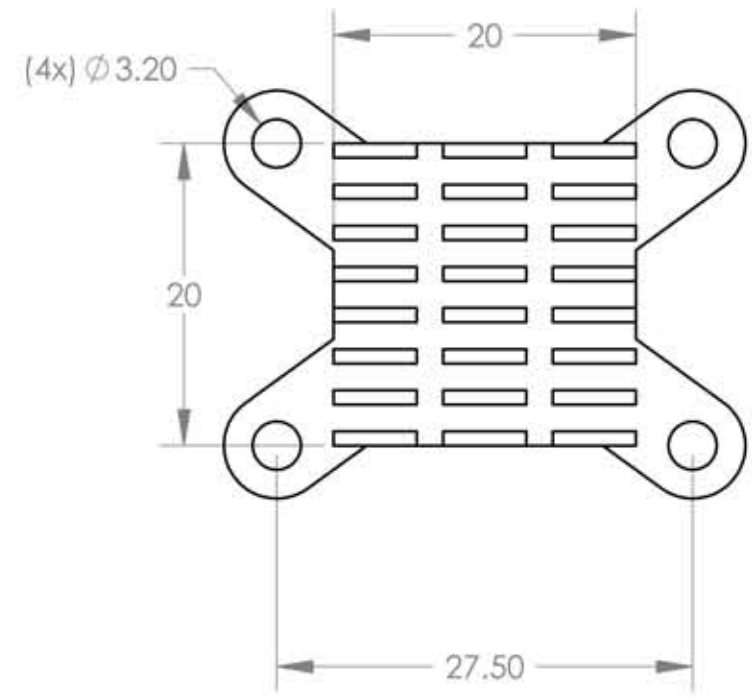
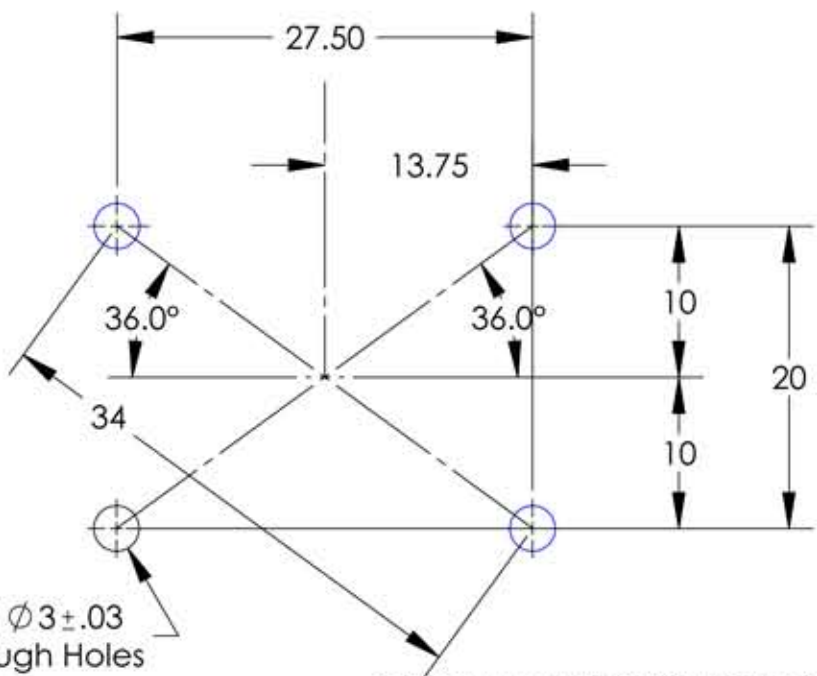
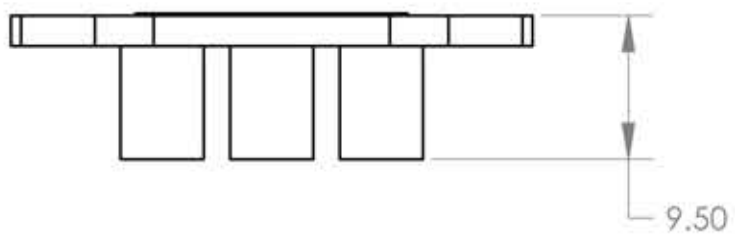
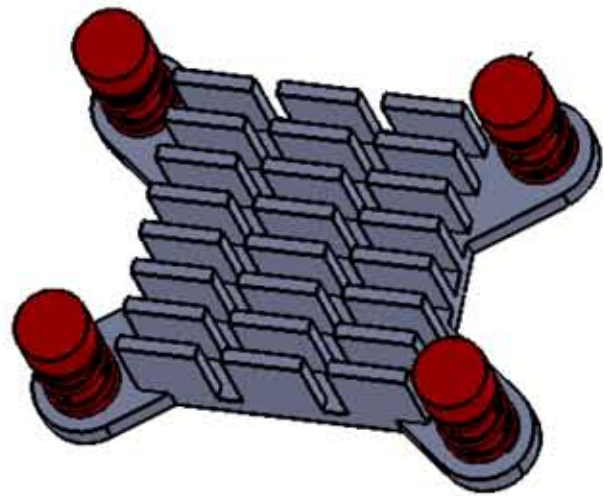
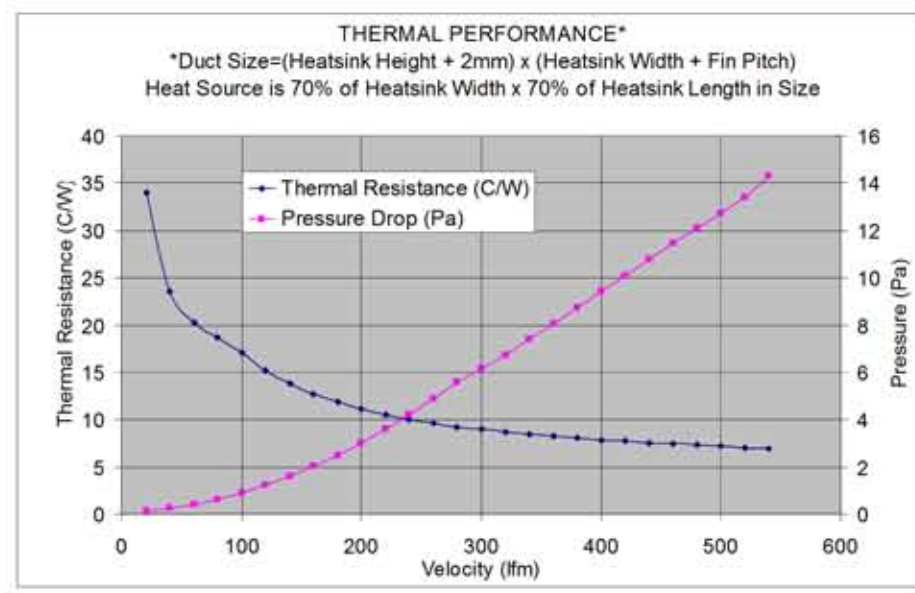
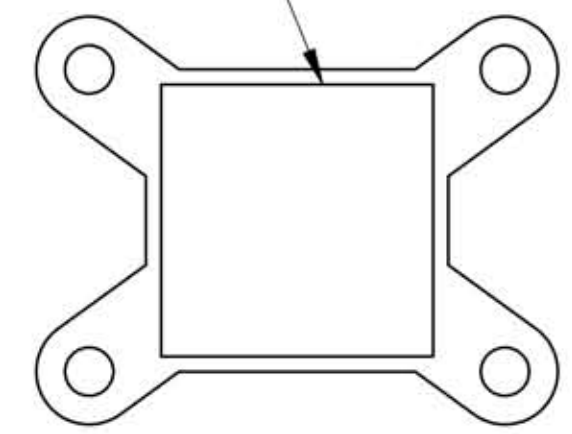

- NOTES:
1. MATERIAL: ALUMINUM 6063-T5
 2. FINISH: BLACK ANODIZE
 3. ALL TOLERANCES APPLY AFTER FINISHING.
 4. REMOVE BURRS AND BREAK SHARP EDGES.

UNLESS OTHERWISE SPECIFIED DIMENSIONS ARE IN mm TOLERANCE ARE:			DO NOT SCALE THIS DRAWING	
DECIMALS	FRACTIONS	ANGLES	APPROVALS	DATE
0-6mm ± .10			E.T.	12/01/2010
6-17mm ± .15		±.5°	CHECKED	E.T.
17-30mm ± .20			RESP ENG	
REMOVE BURRS & SHARP EDGES			MFG ENG	
ALL MACHINED SURFACES			QUAL ENG	
MATERIAL Aluminum 6063-T5			THE INFORMATION CONTAINED IN THIS DRAWING IS THE SOLE PROPERTY OF COOLING SOURCE CORPORATION. ANY REPRODUCTION IN PART OR WHOLE WITHOUT THE WRITTEN PERMISSION OF COOLING SOURCE CORPORATION IS PROHIBITED.	
FINISH Black Anodize				

Cooling Source Confidential



SIZE B	DWG NO. CS86720095B1X	REV A
SCALE: 3: 2		SHEET: 1 OF 1